

Hydraulic
Oil Coolers

2000 series

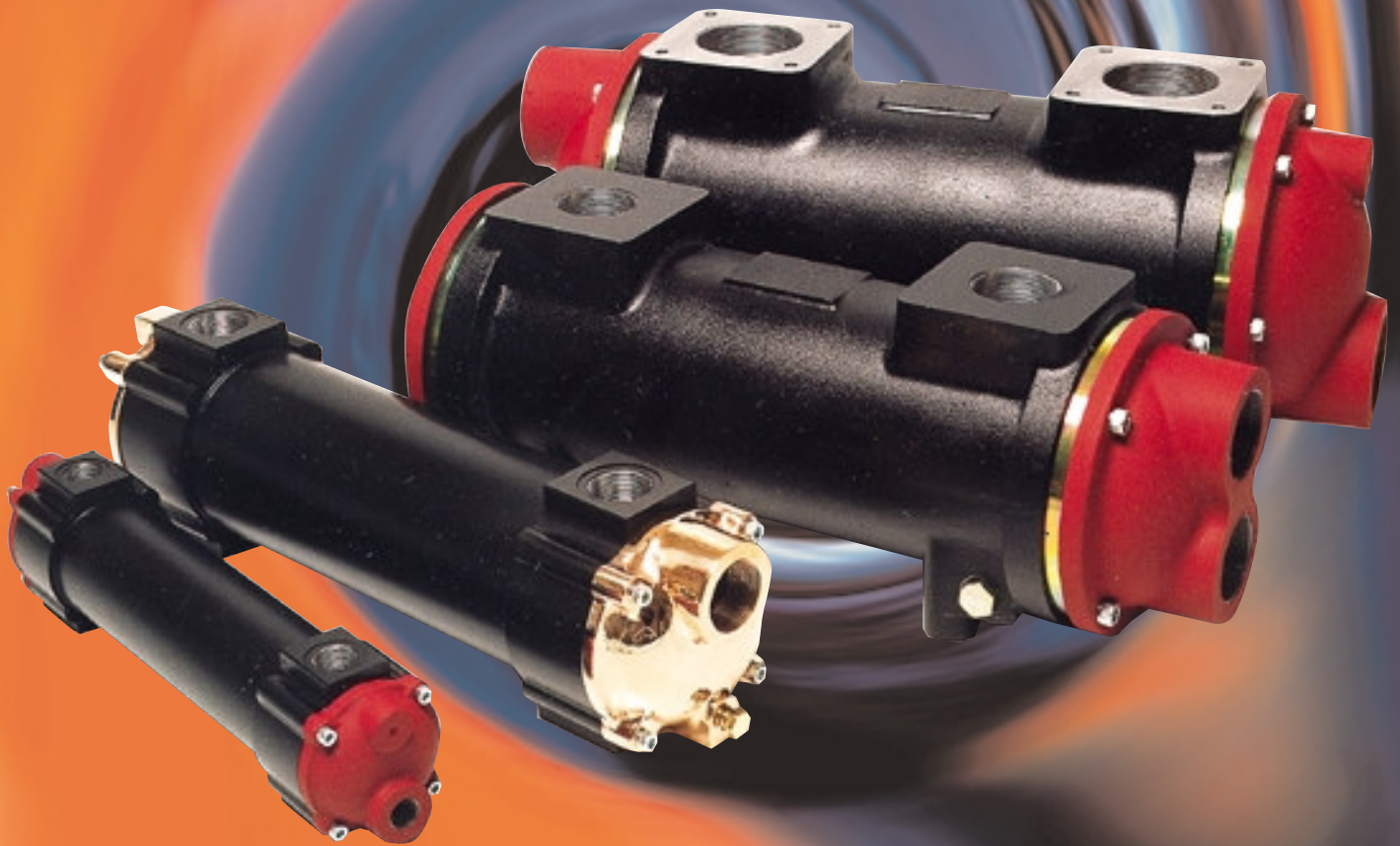

THERMEX

Installation

The illustration shows the correct position of the oil and water connections for horizontal and vertical mounting to ensure that the coolers operate full of water. The cooler is usually mounted in the system return line or drain line to tank and the water should be connected in counter flow to the oil flow. Long lengths of unsupported pipe or excessive pipe

vibration should be avoided and where there are extreme fluctuations in flow or pressure it may be advisable to mount the cooler 'off-line' with its own recirculating pump.

A check valve to by-pass oil across the cooler under cold starting conditions is recommended especially for oil with a high viscosity.

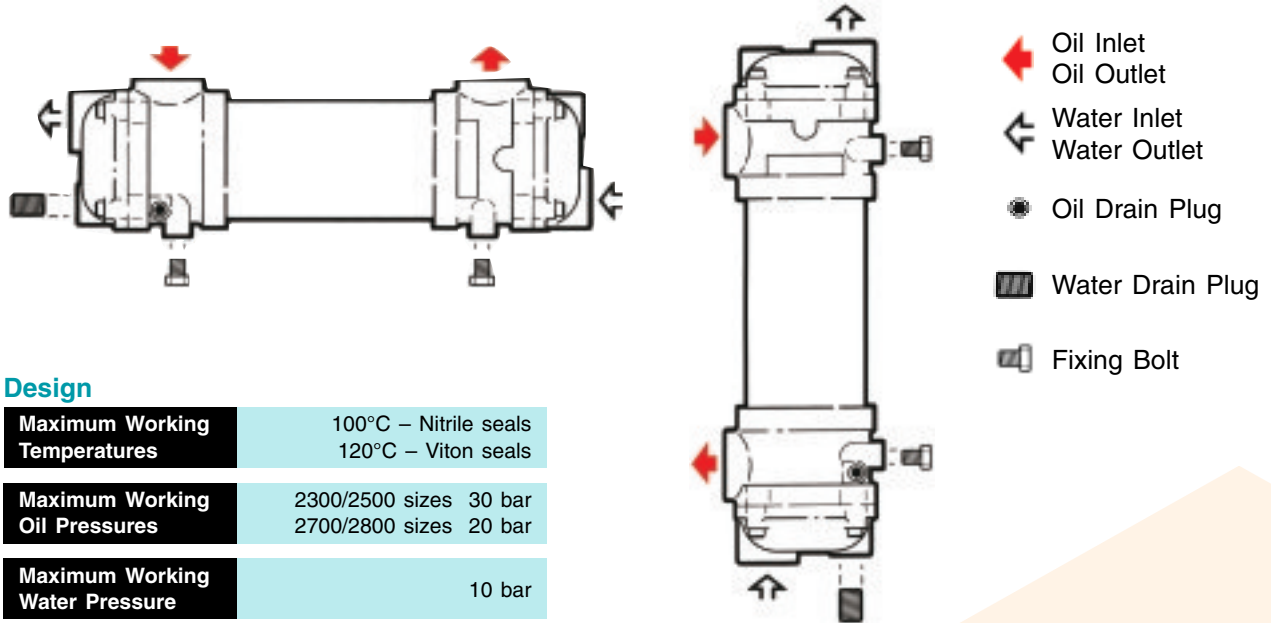

Design

Maximum Working Temperatures	100°C – Nitrile seals 120°C – Viton seals
Maximum Working Oil Pressures	2300/2500 sizes 30 bar 2700/2800 sizes 20 bar
Maximum Working Water Pressure	10 bar

Materials

These coolers are available in both industrial and marine versions.

Standard Industrial version specifications.

 Tubes 	90/10 Copper/Nickel	ISO: CuNi10Fe1Mn
 Tubeplates 	Naval Brass	ISO: CuZn38Sn1
 Body 	Aluminium (2300 & 2500)	ISO: AISi1MgMn
	(2700 & 2800)	ISO: AISi12
 Headers 	Cast Iron	ISO: R185Gr20
 Leak detection rings 	Carbon Steel (2700 & 2800)	ISO: Fe430A
 Seals 	Nitrile	

This specification is given by using 2 as the last digit in the cooler code, e.g. 2312
Viton seals for oil temperatures >100°C is given by changing the last digit to 3, e.g. 2313

Marine version specification differences.

 Headers 	Gunmetal	ISO: GCuSn5Pb5Zn5
------------------	----------	-------------------

This specification is given by using 4 as the last digit in the cooler code, e.g. 2314
Viton seals for oil temperatures >100°C is given by changing the last digit to 5, e.g. 2315

Special Marine version specification differences for severely polluted or poor quality water.

 Headers 	Gunmetal	ISO: GCuSn5Pb5Zn5
 Tubeplates 	90/10 Copper/Nickel	ISO: CuNi10Fe1Mn
 Tubes 	70/30 Copper/Nickel	ISO: CuNi30Mn1Fe

This specification is given by using 6 as the last digit in the cooler code, e.g. 2316
Viton seals for oil temperatures >100°C is given by changing the last digit to 7, e.g. 2317

Performance

The following tables give typical examples of cooler performance at specified oil and water flows using Viscosity Grade 37 oil at an inlet temperature of 60°C and a water supply temperature of 20°C. This is for general cooler selection only; performance curves are also provided for more accurate selection. If you require help with cooler selection

please contact the Thermex Sales Department.

Where sea water is the cooling medium, the water flow rate should be controlled to fall within the limits shown in the following table.

Prolonged use with polluted harbour or estuary water outside these flow limits may result in tube failure.

Type	Heat Dissipated kW	Oil Flow litre/min	Oil Pressure Drop		Water Flow litre/min	Head loss		Sea water Flow	
			kPa	bar		kPa	bar	min litre/min	max litre/min
2312	3.6	40	40	0.4	8	1	0.01	20	45
2322	6	50	60	0.6	8	1	0.01		
2332	10	65	50	0.5	13	3	0.03		
2342	15	80	80	0.8	16	5	0.05		
2352	19	90	60	0.6	19	8	0.08		
2362	24	100	90	0.9	21	13	0.13		
2372	31	120	120	1.2	24	15	0.15		
2512	17	120	60	0.6	30	1	0.01	50	120
2522	25	140	70	0.7	40	2	0.02		
2532	32	160	60	0.6	45	4	0.04		
2542	42	180	90	0.9	50	6	0.06		
2552	51	200	80	0.8	60	10	0.10		
2562	68	220	100	1.0	70	17	0.17		
2572	85	250	80	0.8	87	30	0.30		
2582	110	280	110	1.1	120	65	0.65		
2592	135	300	170	1.7	120	75	0.75		
2712	92	340	50	0.5	170	18	0.18	100	210
2722	124	360	100	1.0	180	23	0.23		
2732	140	380	80	0.8	190	29	0.29		
2742	175	400	120	1.2	200	37	0.37		
2752	208	420	160	1.6	210	46	0.46		
2762	241	440	180	1.8	220	59	0.59		
2812	124	460	40	0.4	230	16	0.16	140	300
2822	168	490	70	0.7	245	20	0.20		
2832	193	520	60	0.6	260	26	0.26		
2842	240	550	80	0.8	275	33	0.33		
2852	288	580	100	1.0	290	42	0.42		
2862	339	610	110	1.1	305	54	0.54		

Cooler Selection

Oil pressure drop correction factor/oil viscosity (cSt)

cSt	10	15	20	25	30	40	50	75	100	150	200	300
c.f.	0,7	0,9	1,0	1,1	1,3	1,5	1,7	2,2	2,7	3,6	4,5	6,3

The following curves provide a more precise selection than the general table. The method of selection is as follows:

1. Calculate the specific heat dissipation (P) using the following expression:

$$P = \frac{E}{th_1 - tc_1}$$

Where **E** = required heat dissipation (kW)
th₁ = oil inlet temperature to cooler (°C)
tc₁ = water supply temperature (°C)

2. Select cooler part number from graph A at value of P obtained in step 1 using the appropriate oil flow through cooler.
3. The pressure drop can be read off graph B. Note that the graphs are for Viscosity Grade 37 oil at 60°C. For other temperatures or viscosities multiply the pressure drop obtained by the correction factor in the following table.
4. The water flow required is given in the general selection table.
5. Where values for P are outside the standard graphs the Thermex sales department can be contacted for a more accurate selection.

2300

Series

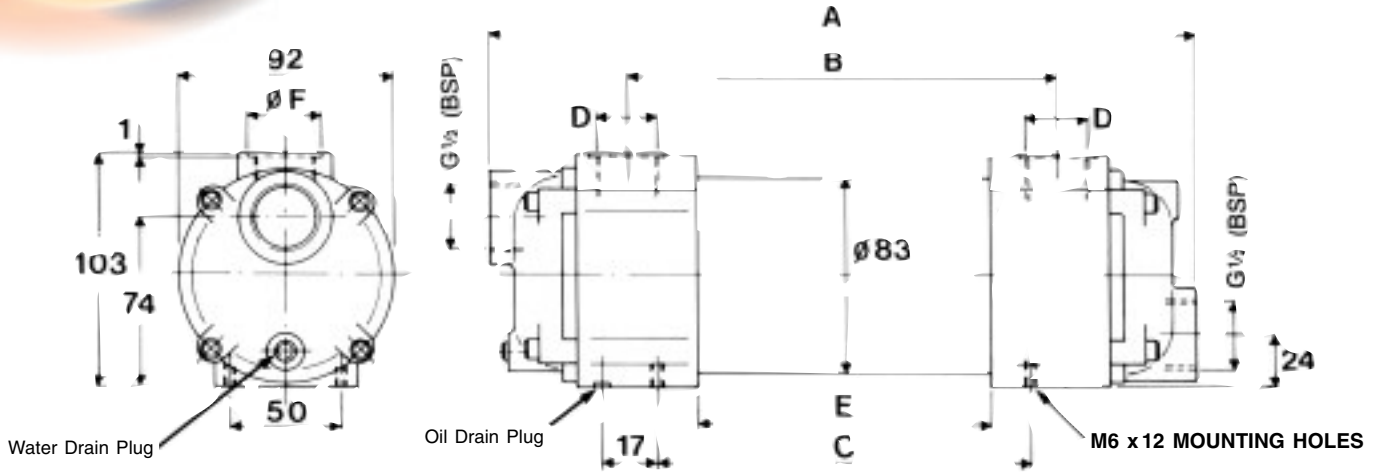

TYPE	A (mm)	B (mm)	C (mm)	D (BSP)	E (mm)	ØF (mm)	Kg	Oil Vol (l)	Water Vol (l)
2312	175	59	*	G ¹ / ₂	—	29.1	3	0.3	0.4
2322	259	135	117	G ³ / ₄	—	36	4	0.5	0.5
2332	345	221	203	G ³ / ₄	—	36	5	0.7	0.6
2342	443	319	301	G ³ / ₄	263	36	5	1.0	0.7
2352	571	447	429	G ³ / ₄	391	36	6	1.3	0.9
2362	717	587	575	G1	537	—	7	1.7	1.1
2372	895	765	753	G1	715	—	8	2.2	1.4

*On Model No. 2310 two M6 x 12 mounting holes are provided on base midway between oil port centres.
Add suffix H to part number for ³/₄" BSP water connections.

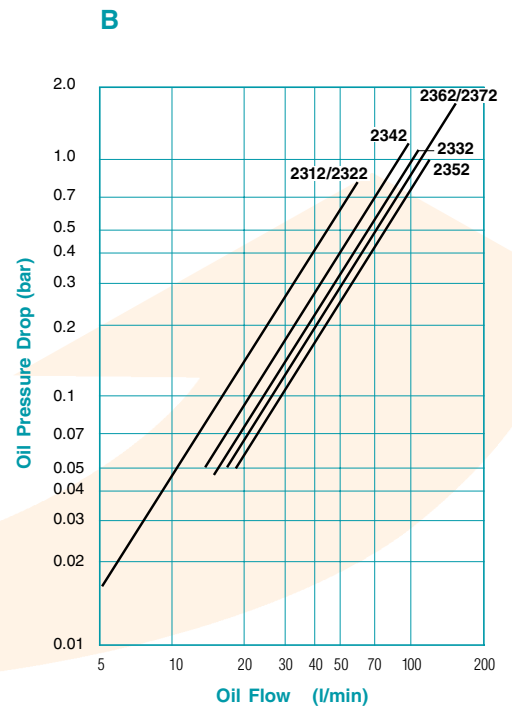
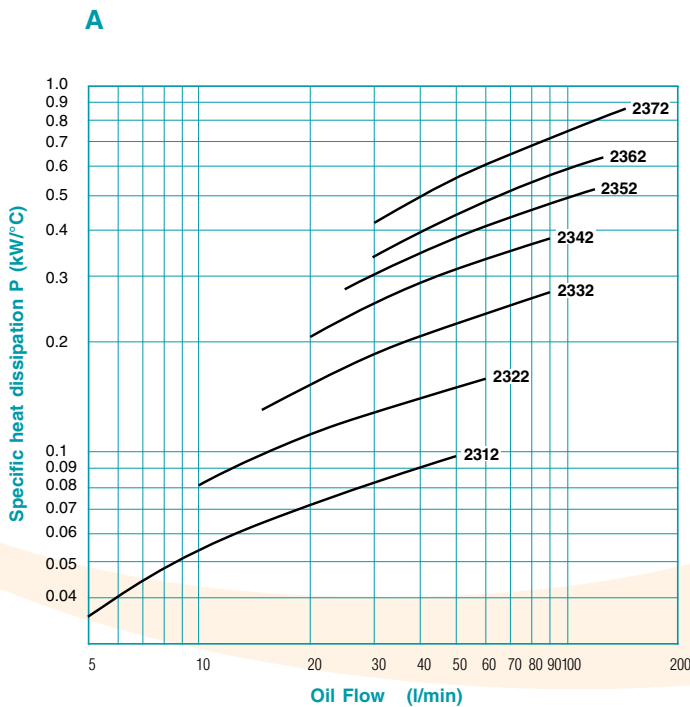

2500 Series

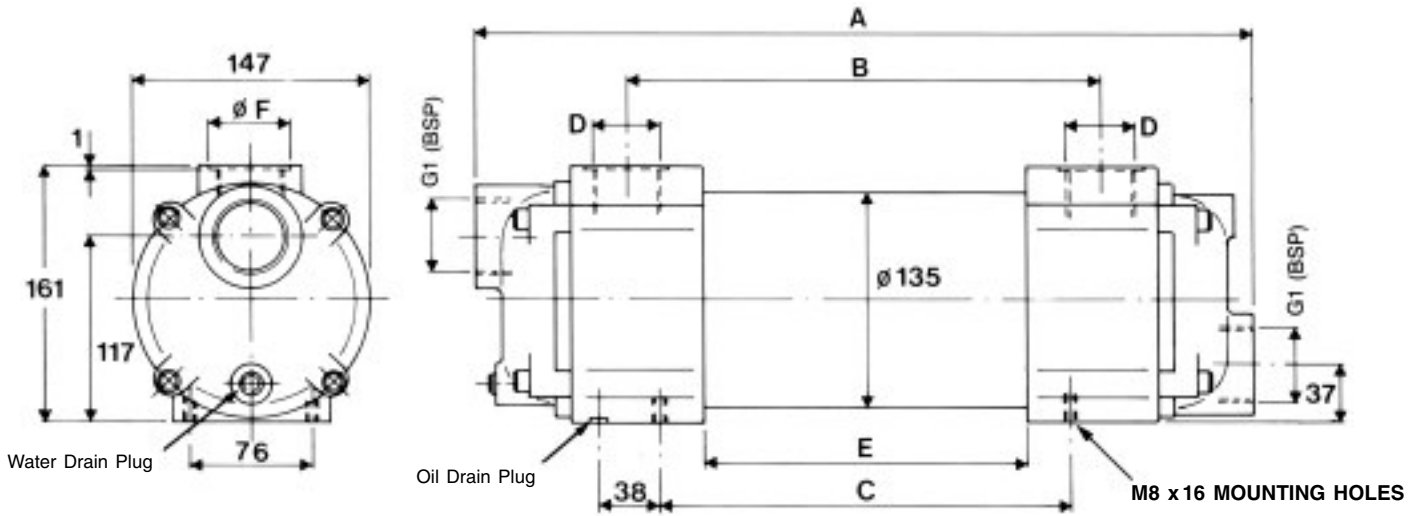

TYPE	A (mm)	B (mm)	C (mm)	D (BSP)	E (mm)	ØF (mm)	Kg	Oil Vol (l)	Water Vol (l)
2512	291	129	75	G1	—	45	10	1.4	1.4
2522	377	199	161	G1¼	—	53	12	1.9	1.7
2532	475	297	259	G1¼	—	53	13	2.5	2.1
2542	603	425	387	G1¼	333	53	14	3.5	2.6
2552	749	571	533	G1½	479	59	17	4.5	3.2
2562	927	749	711	G1½	657	59	20	5.8	3.9
2572	1129	951	913	G1½	859	59	23	7.3	4.8
2582	1381	1203	1165	G1½	1111	59	27	9.0	5.8
2592	1727	1549	1511	G1½	1457	59	32	11.5	7.2

Add suffix H to part number for 1½" BSP water connections. ('A' = +14mm)

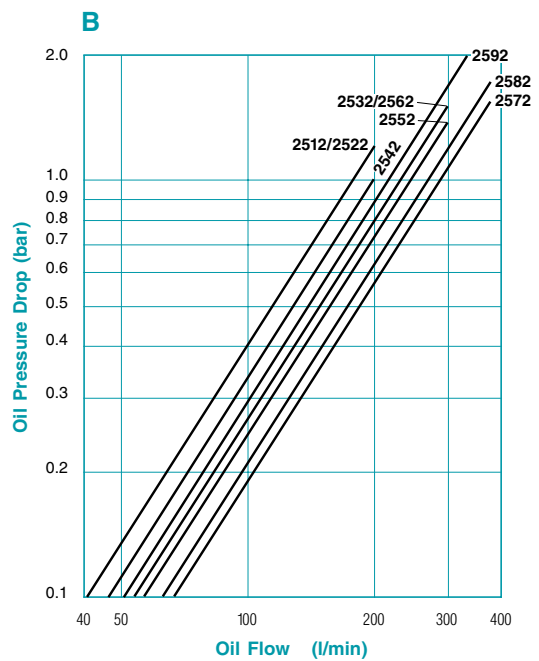
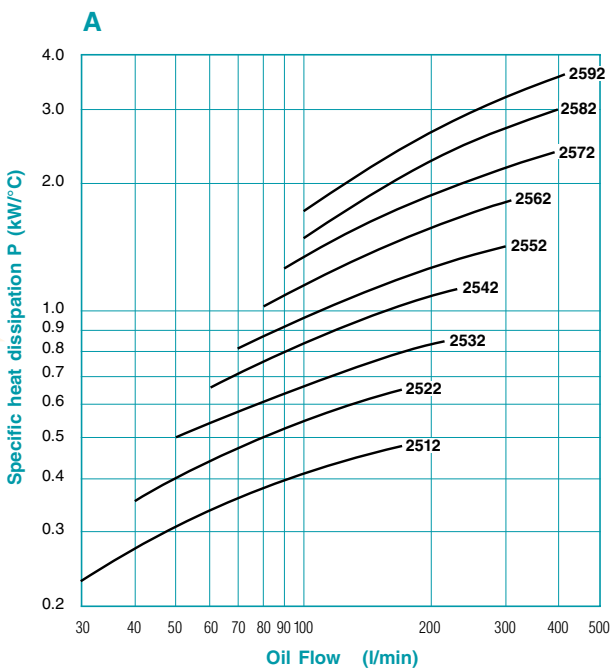

2700 Series

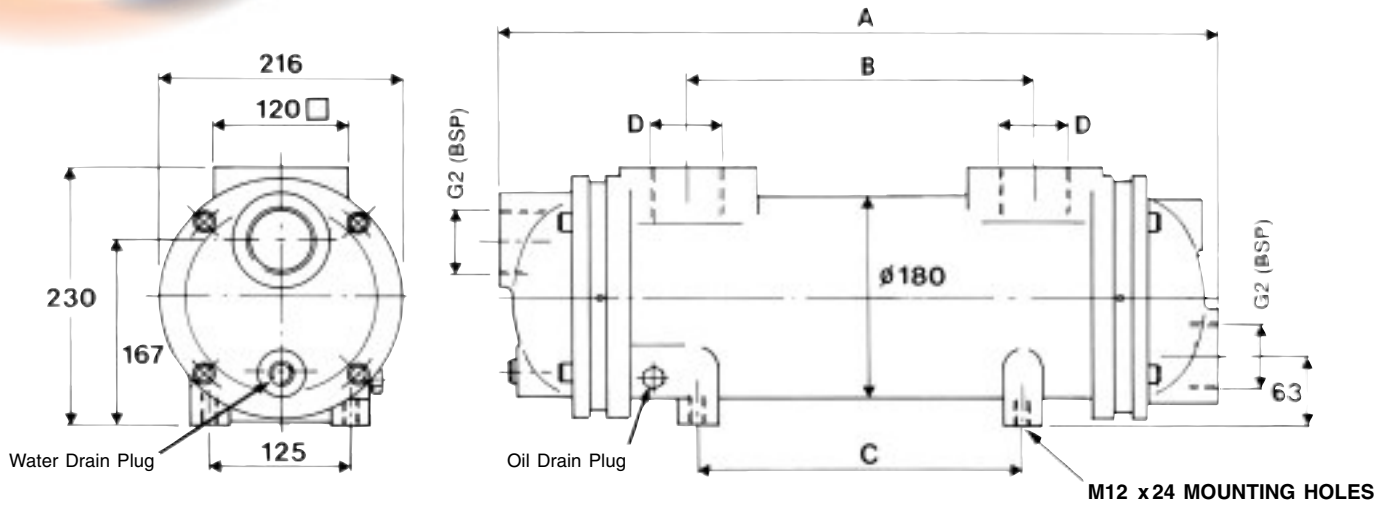

TYPE	A (mm)	B (mm)	C (mm)	D (BSP)	Kg	Oil Vol (l)	Water Vol (l)
2712	650	326	306	G2	38	5.5	5.0
2722	796	472	452	G2	43	7.0	6.0
2732	974	650	630	G2	48	9.0	7.5
2742	1176	852	832	G2	55	11.0	9.0
2752	1428	1104	1084	G2	63	14.0	10.5
2762	1777	1453	1433	G2	74	17.5	13.0

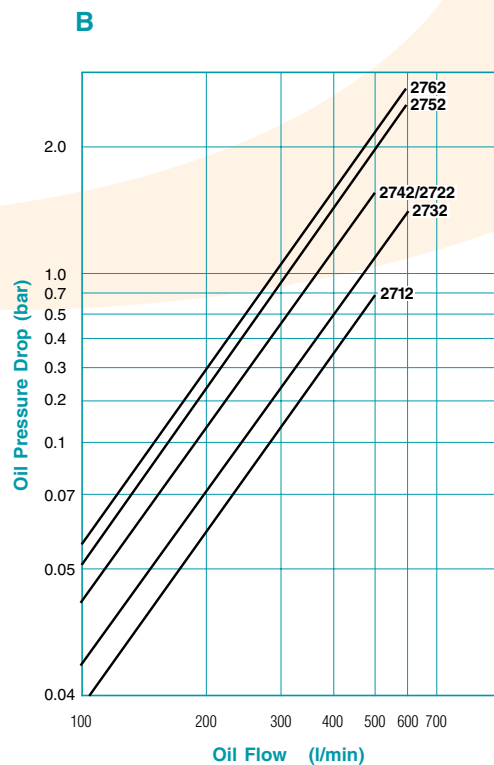
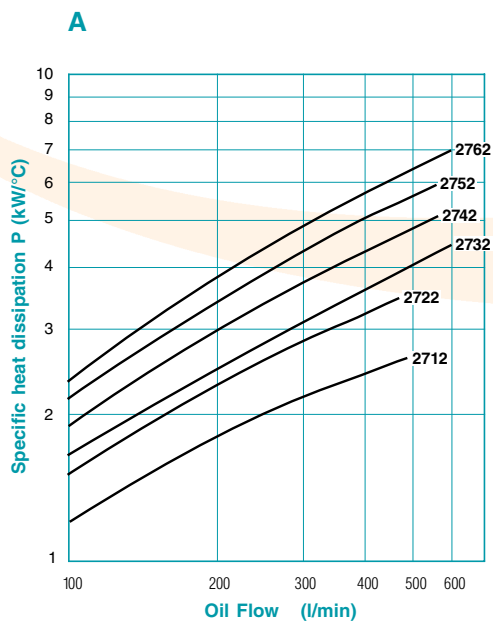

2800 Series

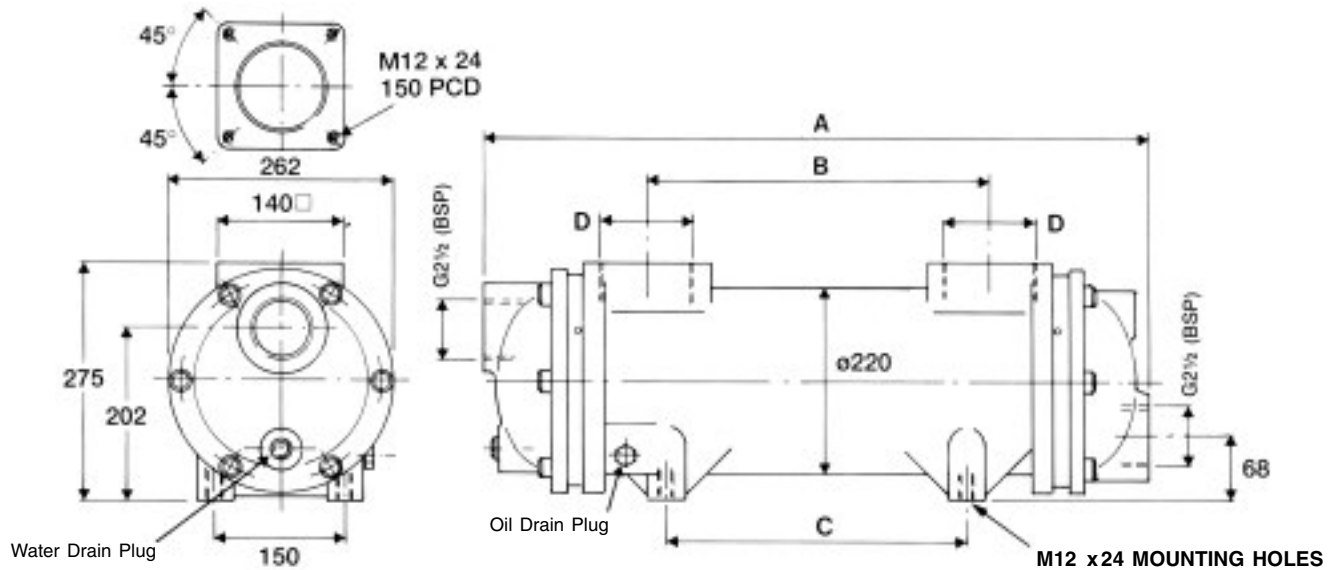

TYPE	A (mm)	B (mm)	C (mm)	D (BSP)	Kg	Oil Vol (l)	Water Vol (l)
2812	684	326	306	G3	48	9.0	7.5
2822	830	472	452	G3	54	11.5	9.0
2832	1008	650	630	G3	62	15.0	10.5
2842	1210	852	832	G3	71	18.5	13.0
2852	1462	1104	1084	G3	82	23.0	15.5
2862	1811	1453	1433	G3	97	29.5	19.0

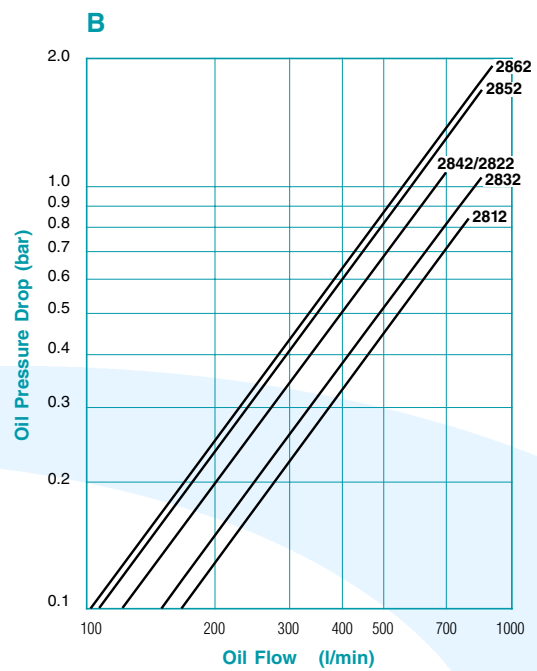
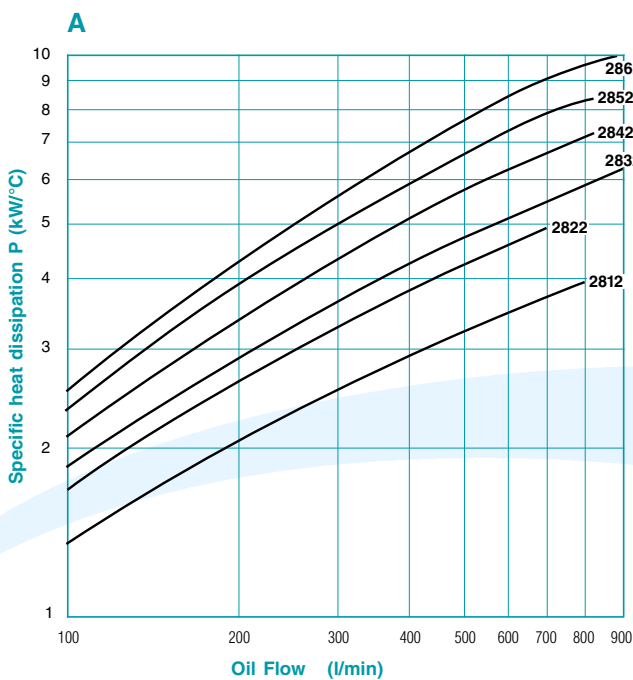

Series 2000

These Oil Coolers have been designed specifically for Hydraulic systems, but they are equally suitable for cooling lubricating oils, heat transfer fluids, etc. The high efficiency tubestack is fully floating to minimise thermal stresses and incorporates the unique Thermex tube-to-tubeplate joint ensuring reliability under extreme operating conditions.

The 2700 and 2800 ranges have twin seals and witness rings fitted as standard to provide maximum protection against fluid cross-contamination.

- 1 Tube Plate
- 2 Tubes
- 3 Body Shell
- 4 Seal
- 5 Header

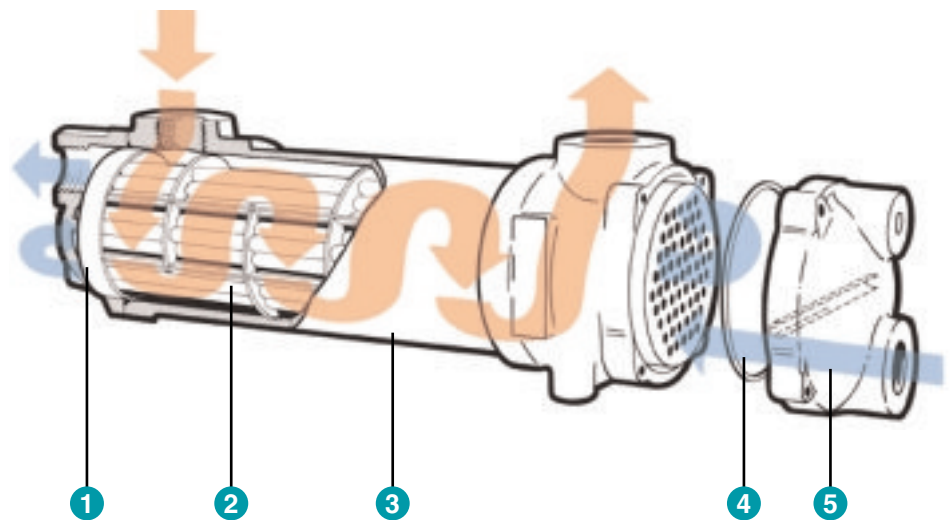

The information contained in this brochure was correct at the time of going to print. Thermex policy is one of continuous product evaluation and development. The right is reserved to change specifications as described in this publication at any time without prior notice.



Thermex Ltd, Merse Rd, North Moons Moat, Redditch, Worcestershire B98 9HL, UK
Tel: +44 (0)1527 62210 Fax: +44 (0)1527 60138 Web: www.thermex.co.uk E-mail: enquiry@thermex.co.uk

Registered in England 1420384



Certificate No. FM 11544
BS EN ISO 9001